

Product description

MAIN FEATURES

COMPACT, UP TO 12 POSITIONS

- › 25'000 switching cycles with up to 6 Ncm switching torque
- › Gold plated contacts: 3 micron
- › Robust metal bushing and shaft
- › Operating temperature range: -40 to +85 °C
- › IP68 front panel sealing
- › Various options and customizations

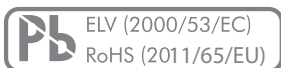

PRODUCT VARIETY

- Soldering eyelets or pins for PCB
- Poles x positions per wafer from 1 x 12 to 4 x 3
- 1 or 2 wafers
- Detent angle 30°, 36° or 60°
- Shorting or non-shorting
- Switching torque: 2, 4 or 6 Ncm
- Front panel sealing IP60 or IP68
- Configurable end stops
- Shaft diameter: 3, 4 or 6 mm
- Shaft length

TYPICAL APPLICATIONS

- Industrial controls
- Avionics, measurement and test systems
- Medical and audio equipment
- Transport and constructions machines

01



POSSIBLE CUSTOMIZATIONS

- Shaft dimension and shape
- Central lock dimensions
- Switching torque
- Hollow shaft, inner shaft
- Push function | pull to turn function
- Others

Dimensions and pin assignment

SWITCH DESIGN

WITH SOLDERING EYELETS

1 Wafer

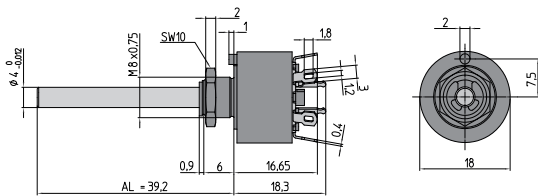

SW = Key spanner

2 Wafers

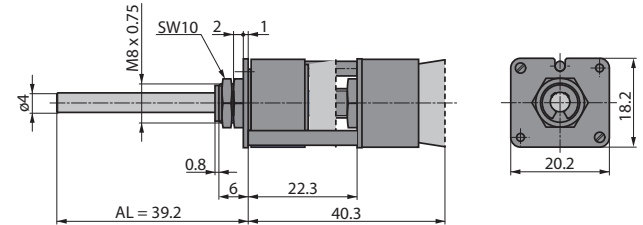

WITH PINS FOR PCB

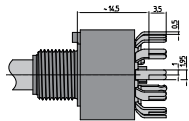

PIN ASSIGNMENT AND DRILLING DIAGRAM

30° DETENT ANGLE

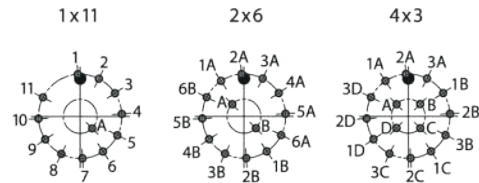
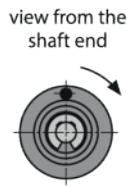
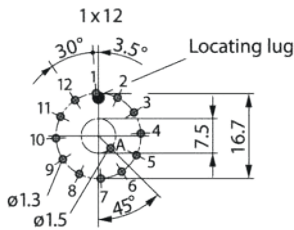

36° DETENT ANGLE

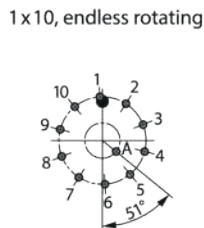
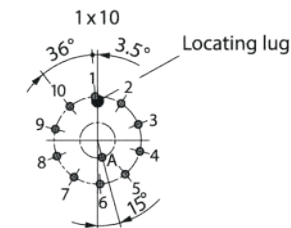

60° DETENT ANGLE

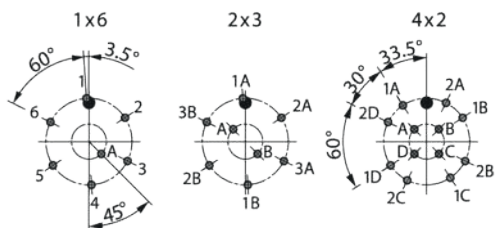

Dimensions in mm
Tolerances according to DIN ISO 2768-1 (m), unless otherwise specified

Dimensions and pin assignment

FRONT PANEL CUT OUT

SHAFT Ø 3 MM, NUT M6 X 0.75

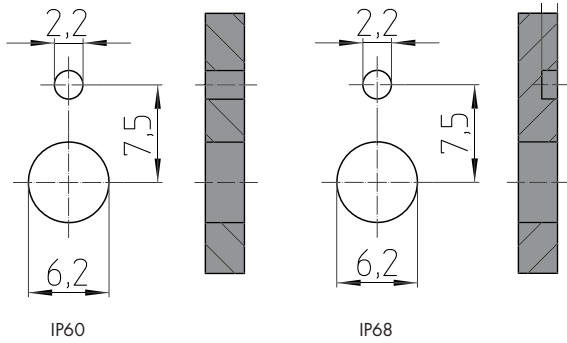

SHAFT Ø 4 MM, NUT M8 X 0.75

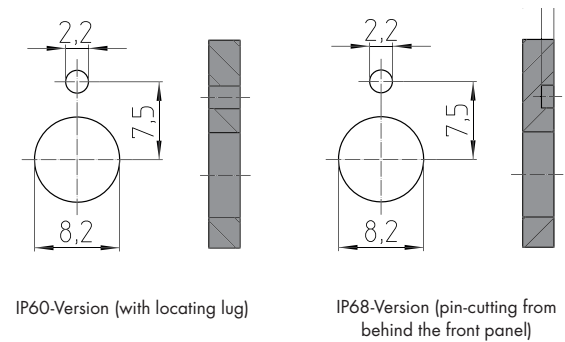

SHAFT Ø 6 MM, NUT M10 X 0.75

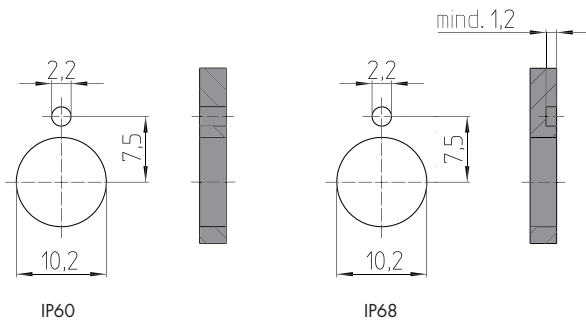

NUT (SUPPLIED)

SHAFT Ø 3 MM

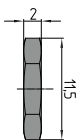

Screw wrench 10 mm M6 x 0.75

SHAFT Ø 4 MM

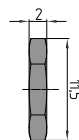

Screw wrench 10 mm M8 x 0.75

SHAFT Ø 6 MM

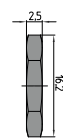

Screw wrench 14 mm M10 x 0.75

Dimensions in mm
Tolerances according to DIN ISO 2768-1 (m), unless otherwise specified

ORDERING INFORMATION

ORDERING CODE

01	-	-	-	-	-	-	-	-	-	-	-	-	-
----	---	---	---	---	---	---	---	---	---	---	---	---	---

BASIC CODE
See standard types

NUMBER OF WAFERS
See standard types

NUMBER OF POLES
See standard types

FACTORY SET CHARACTER
See standard types

SWITCHING MODE
3 Shorting
4 Non-shorting

SWITCHING TORQUE
- 4 Ncm (standard)
M 2 Ncm
N 6 Ncm

SHAFT DIAMETER
0 4 mm
M 3 mm
N 6 mm

NUMBER OF POSITIONS
00 Standard
11 11 positions
10 10 positions
09 9 positions
08 8 positions
07 7 positions
06 6 positions
05 5 positions
04 4 positions
03 3 positions
02 2 positions

SHAFT LENGTH (AL)
000 59 mm (Ø 3 mm shaft)
 39.2 mm (standard Ø 4 mm shaft)
 28 mm (Ø 6 mm shaft)
xxx¹ Customized
 (shaft length rounded to next 0.5 mm,
 e.g. 10.3 mm = 10.5 mm or 10 mm)
¹ Customized shaft length (AL)
 AL measured from base of housing (see picture below)
 Max. shaft length (AL):
 Ø 3 and 4 mm = 80 mm
 Ø 6 mm = 28 mm

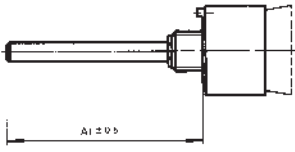















PIN STYLE | IP SEALING
00 Soldering eyelets | IP60
20 Pins for PCB | IP60
30² Soldering eyelets | IP68
70² Pins for PCB | IP68
² Only deliverable for version with a wafer with 3 or 4 mm shaft diameter









ORDERING INFORMATION

PREFERENCE TYPES SELECTION CHART¹

DETENT ANGLE 30°, SHORTING

CONTACT ARRANGEMENT	NUMBER OF WAFERS (MAX. 2 WAFERS AVAILABLE)	FUNCTION (POLES X POSITIONS)	PART NUMBER	
			WITH SOLDERING EYELETS	WITH PINS FOR PCB
		1 x 12 endless rotating	01-1123	01-1123-20
		2 x 12 endless rotating	01-2123	-
		1 x 12	01-1183	01-1183-20
		2 x 12	01-2183	-
		1 x 11	01-1113	01-1113-20
		2 x 11	01-2113	-
		2 x 6	01-1263	01-1263-20
		4 x 6	01-2263	-
		4 x 3	01-1433	01-1433-20
		8 x 3	01-2433	-

DETENT ANGLE 30°, NON-SHORTING



CONTACT ARRANGEMENT	NUMBER OF WAFERS (MAX. 1 WAFERS AVAILABLE)	FUNCTION (POLES X POSITIONS)	PART NUMBER	
			WITH SOLDERING EYELETS	WITH PINS FOR PCB
		1 x 12 endless rotating	01-1124	01-1124-20
		1 x 12	01-1184	01-1184-20
		1 x 11	01-1114	01-1114-20
		2 x 6	01-1264	01-1264-20
		4 x 3	01-1434	01-1434-20

¹ For other types | options see ordering code









ORDERING INFORMATION

PREFERENCE TYPES SELECTION CHART¹

DETENT ANGLE 36°, SHORTING

CONTACT ARRANGEMENT	NUMBER OF WAFERS (MAX. 2 WAFERS AVAILABLE)	FUNCTION (POLES X POSITIONS)	PART NUMBER	
			WITH SOLDERING EYELETS	WITH PINS FOR PCB
		1 x 10 endless rotating	01-1103	01-1103-20
		1 x 10	01-1193	01-1193-20

DETENT ANGLE 60°, NON-SHORTING

CONTACT ARRANGEMENT	NUMBER OF WAFERS (MAX. 2 WAFERS AVAILABLE)	FUNCTION (POLES X POSITIONS)	PART NUMBER	
			WITH SOLDERING EYELETS	WITH PINS FOR PCB
		1 x 6 endless rotating	01-1104	01-1104-20
		1 x 6	01-1164	01-1164-20
		2 x 3	01-1234	01-1234-20
		4 x 2	01-1424	01-1424-20

PACKAGING

Foam polystyrene box:

10 pieces

ACCESSORIES AND SPARE PARTS

Hex nut M8 x 0.75:

Part number 4024-81 (10 pieces / bag), brass, nickel plated

Hex nut M6 x 0.75:

Part number 4024-80 (10 pieces / bag), brass, nickel plated

Hex nut M10 x 0.75:

Part number 4024-82 (10 pieces / bag), brass, nickel plated

Stop pins (end stop):

Part number 4007-36 (10 pieces / bag)

Part number 4007-35 (50 pieces / bag)

¹ For other types | options see ordering code

Customized solutions

HOLLOW SHAFT SYSTEM

HOLLOW SHAFT

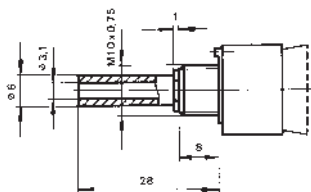

FRONT PANEL CUT OUT

Front panel cut out see on the pages before.

The hollow shaft enables the operation of either two switches or e.g. a switch and a potentiometer. The inner shaft (\varnothing 3 mm) must be ordered separately.

INNER SHAFT

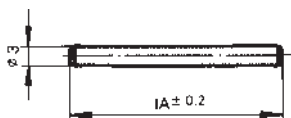

For switches with mounting plate or hollow shaft.
Hollow shaft must to be ordered separately.
Please state exact length.

SWITCH WITH TWO SHAFTS

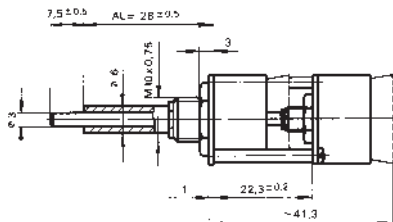

FRONT PANEL CUT OUT

Front panel cut out see on the pages before.

It is possible to operate two switches individually on the same mounting by using two independently rotating shafts. For ordering, the type number of each switch must be given and specified.

Specifications

MECHANICAL DATA

Detent angle positions:	30° detent angle 12 positions 36° detent angle 10 positions 60° detent angle 6 positions
Rotary limitation end stop:	Configurable
Switching torque:	2, 4 or 6 Ncm ($\pm 25\%$ in new condition)
Rotational life:	> 25'000 cycles (tested at room temperature)
Allowed shaft load:	500 N push, 500 N pull and 100 N side load (static at 20 mm from the support surface)
Rotational stop strength:	30° detent angle: > 100 Ncm 36° and 60° detent angle: > 150 Ncm
Fastening torque of nut (front panel mounting):	M6 x 0.75: < 100 Ncm M8 x 0.75: < 300 Ncm M10 x 0.75: < 300 Ncm

ELECTRICAL DATA

Electrical connection:	Soldering eyelets Pins for PCB
Switching voltage:	< 42 VDC (resistive load)
Switching current:	< 2000 mA (resistive load)
Contact resistance:	< 10 m Ω (in new condition)
Switching capacity:	< 1 pF (between the contacts)
Switching function:	1 x 12 to 4 x 3 poles x positions per wafer, max. 2 wafers
Switching mode:	Shorting (for 30° and 36° detent angle) Non-shorting (for 30° and 60° detent angle)
Dielectric strength:	500 VDC during 60 s (pin-to-pin, pin-to-housing)
Insulation resistance:	> 1 G Ω at 500 VDC (pin-to-pin, pin-to-housing, in new condition)

MATERIALS

Shaft:	Stainless steel 1.4305
Bushing housing:	Nickel silver, fiberglass reinforced plastic
Contact surface:	Cu alloy (Au plated)
Insulation material:	Wafer: PEAK or ceramic Rotor: Polybutylen
Soldering leads:	Cu alloy (Au plated)
Hex nut:	Brass (nickel plated)

ENVIRONMENTAL DATA

Operating temperature:	-40 to +85 °C (IEC 60068-2-14)
Storage temperature:	-40 to +85 °C (IEC 60068-2-14)
IP sealing against front panel:	IP60 without sealing IP68 with shaft and front panel sealing (2 bar, 1 h)
Vibration:	10 G _{RMS} at 10 to 2'000 Hz
Flammability:	UL94-HB

SOLDERING CONDITIONS

Hand soldering:	< 340 °C during 2 s
Wave soldering:	< 280 °C during 5 s

©Copyright 2018 by Elma Electronic AG, CH-8620 Wetzikon. Subject to technical modifications, all data supplied without liability.

Please contact our sales team for more details.

China: +86 21 5866 5908
France: +33 388 56 72 50

Germany: +49 7231 97 34 0
Israel: +972 3 930 50 25

Singapore: +65 6479 8552
Switzerland: +41 44 933 41 11

United Kingdom: +44 1234 838 822
United States: +1 510 656 3400